

Datum 15.00 AOD Block A North Elevation

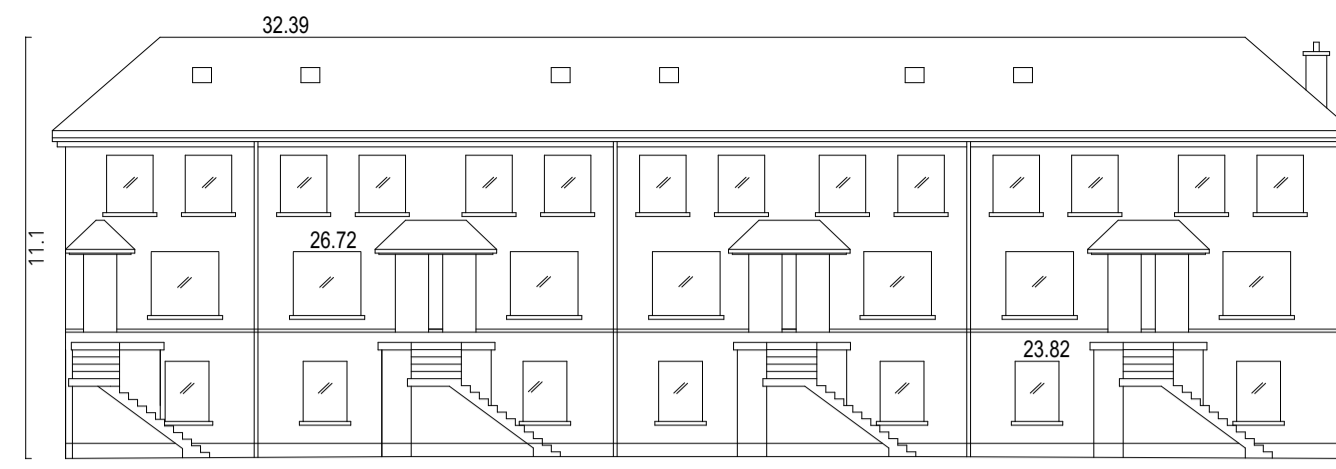

Datum 15.00 AOD Block A South Elevation

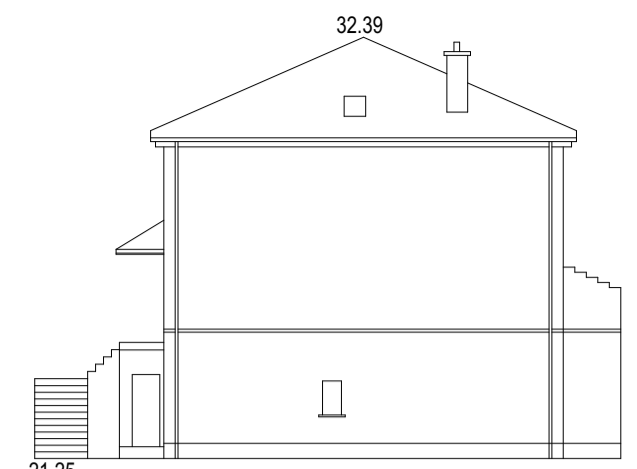

Datum 15.00 AOD Block A East Elevation

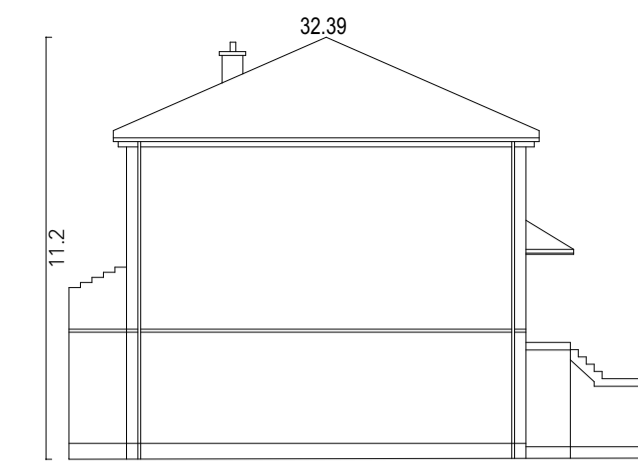

Datum 15.00 AOD Block A West Elevation

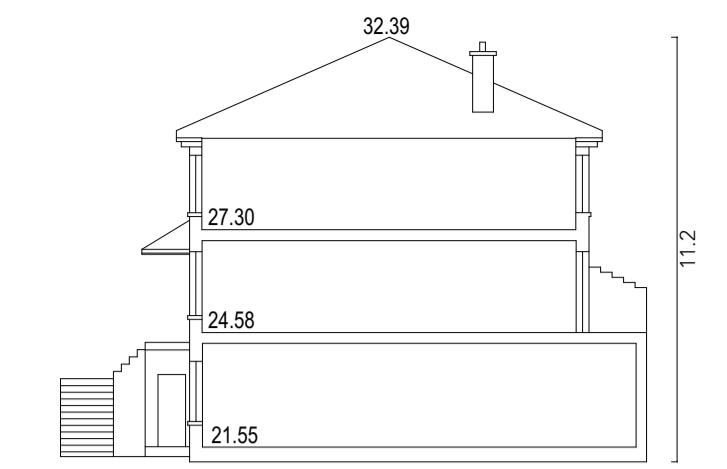

Datum 15.00 AOD Section A-A

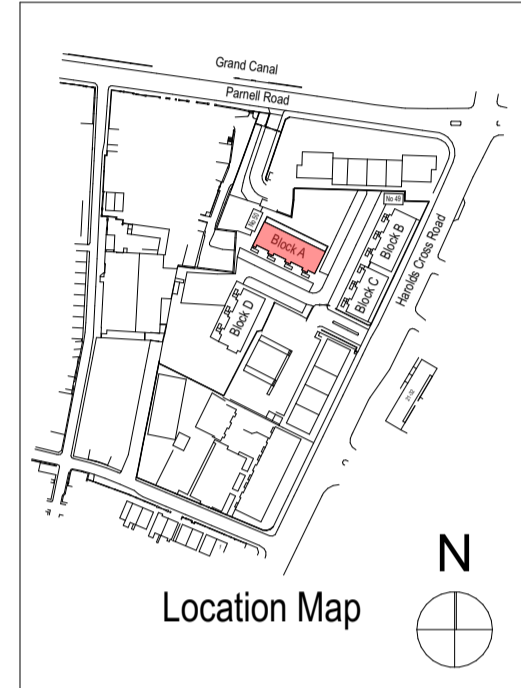

Location Map

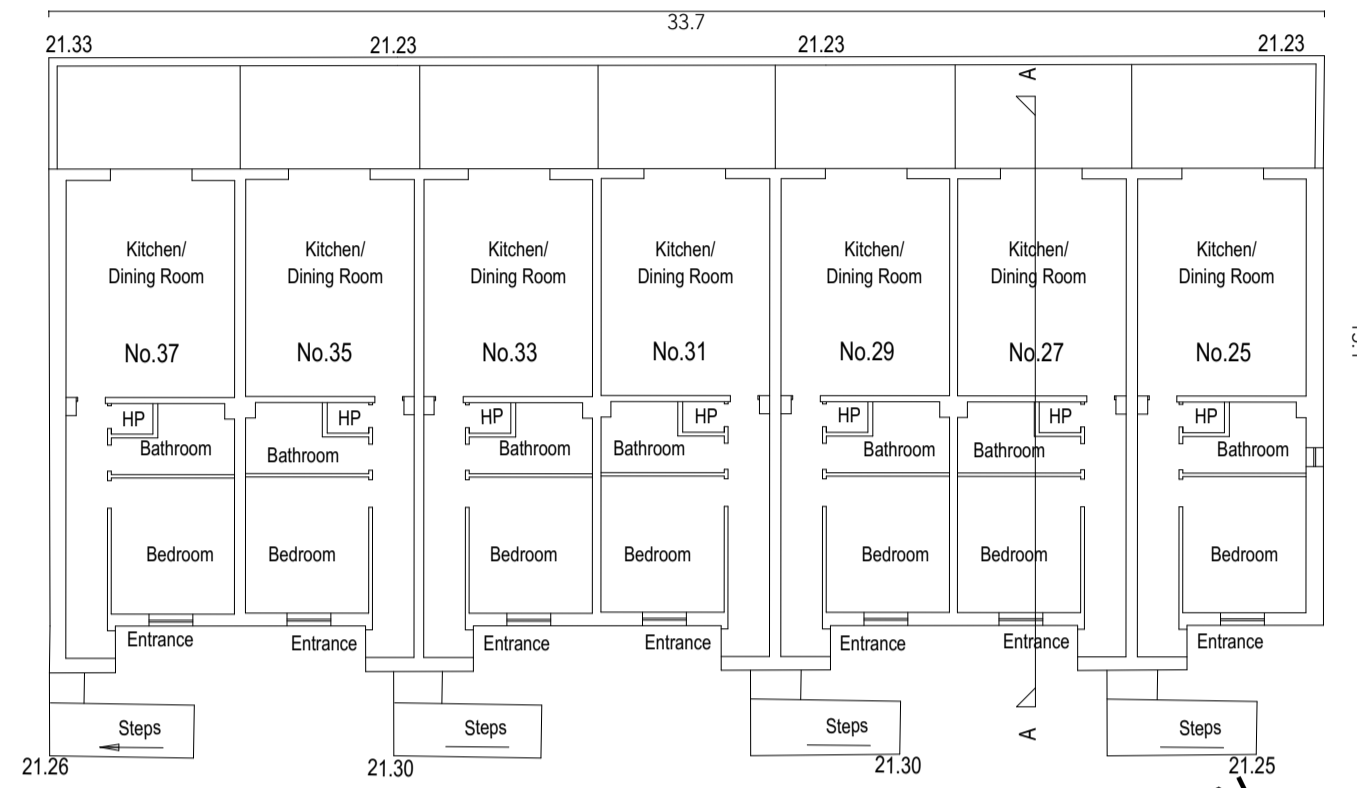

GROUND FLOOR

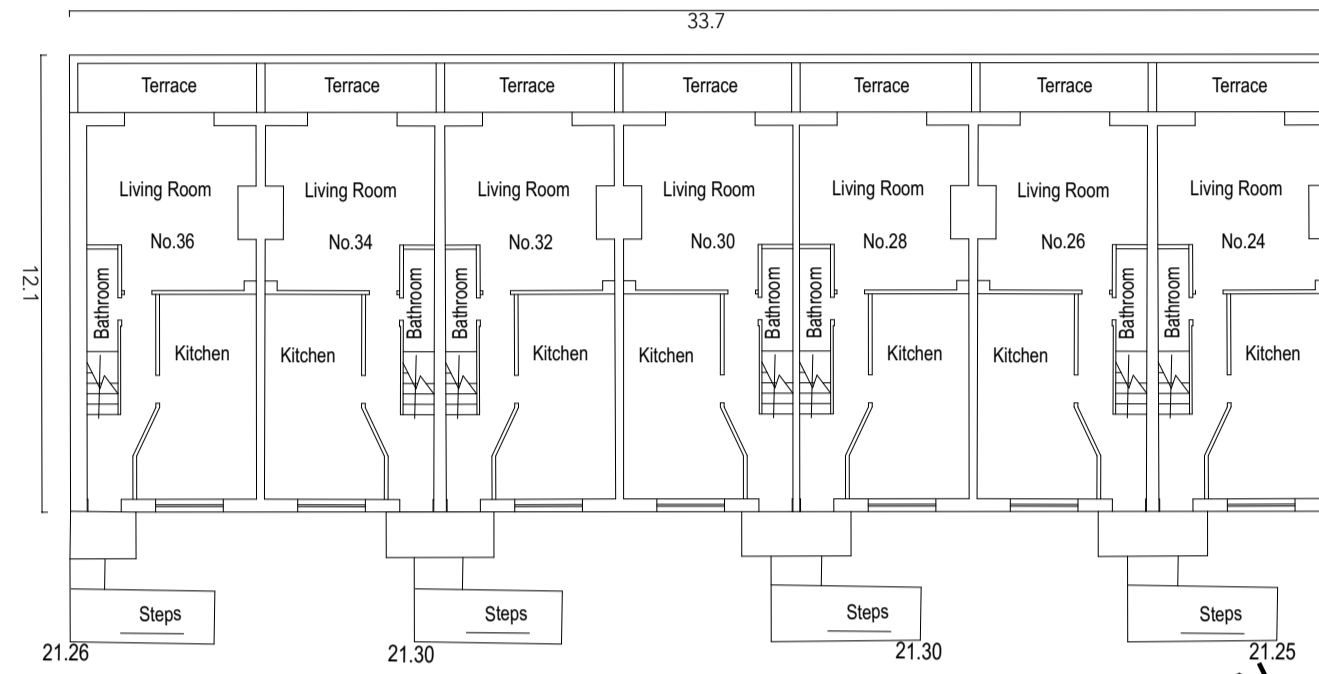

FIRST FLOOR

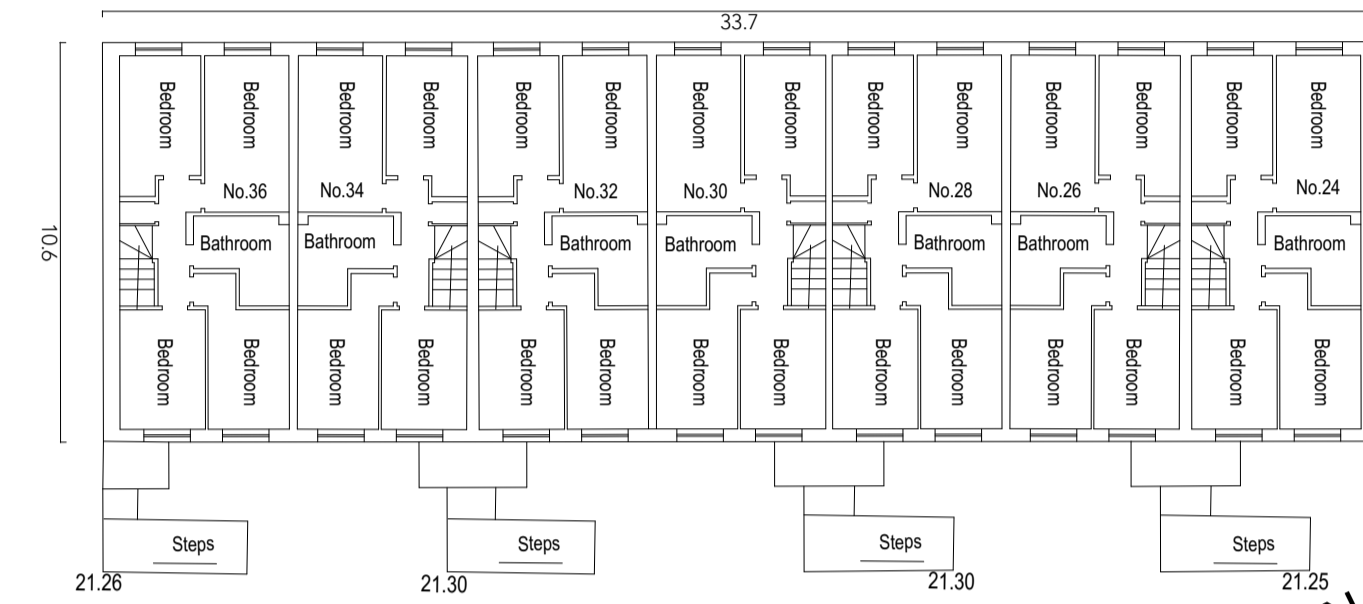

SECOND FLOOR

BLOCK A - DRAWINGS
SCALE 1:200

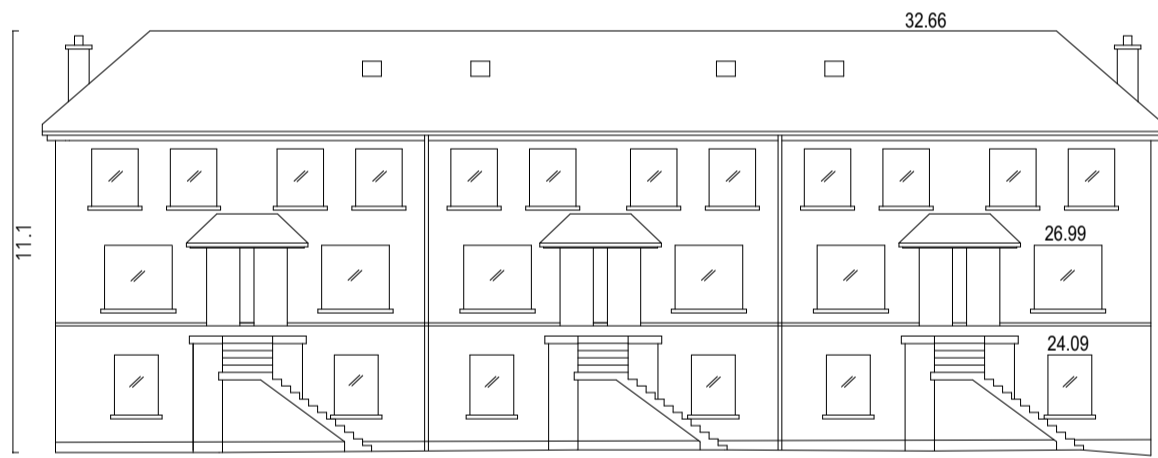

Datum 15.00 AOD Block B West Elevation

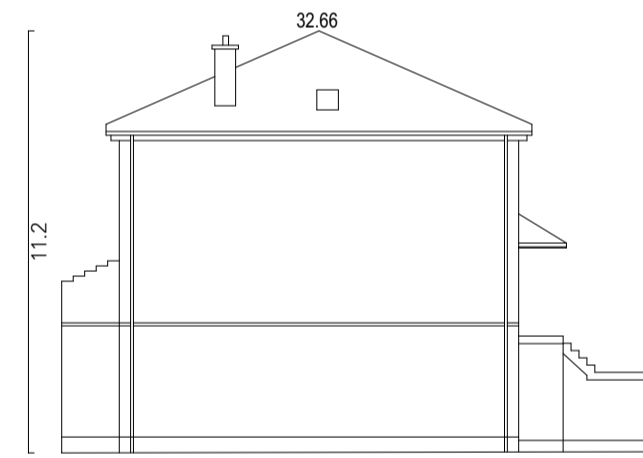

Datum 15.00 AOD Block B North Elevation

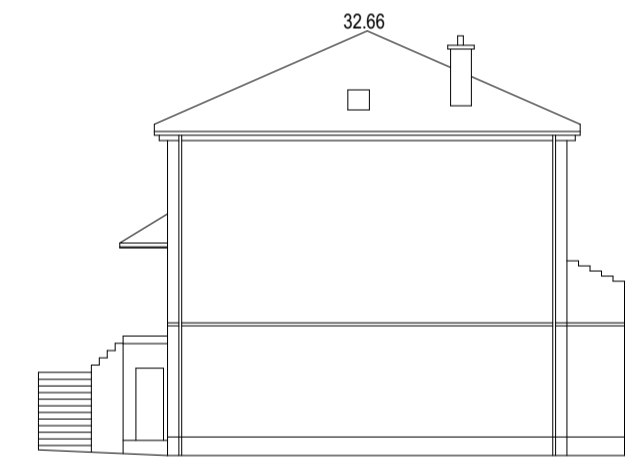

Datum 15.00 AOD Block B South Elevation

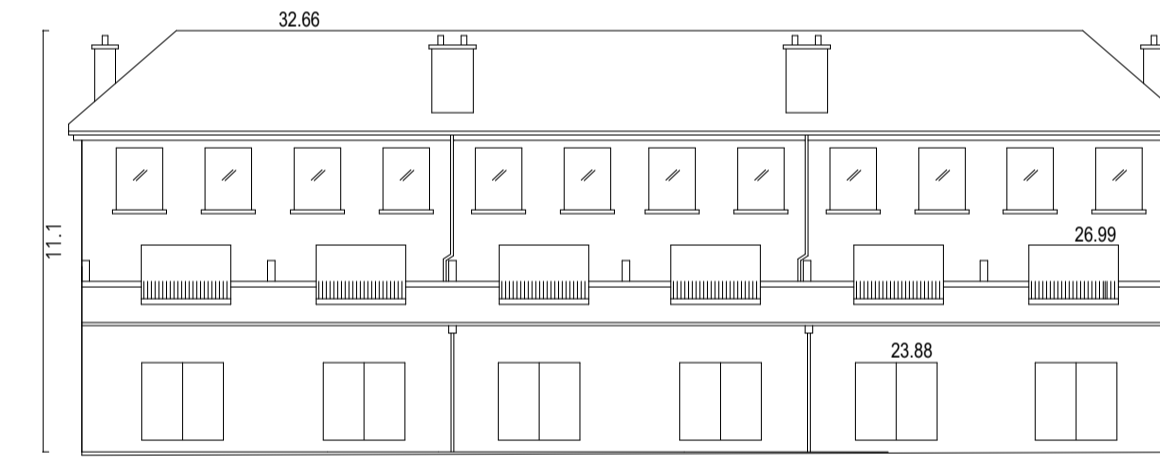

Datum 15.00 AOD Block B East Elevation

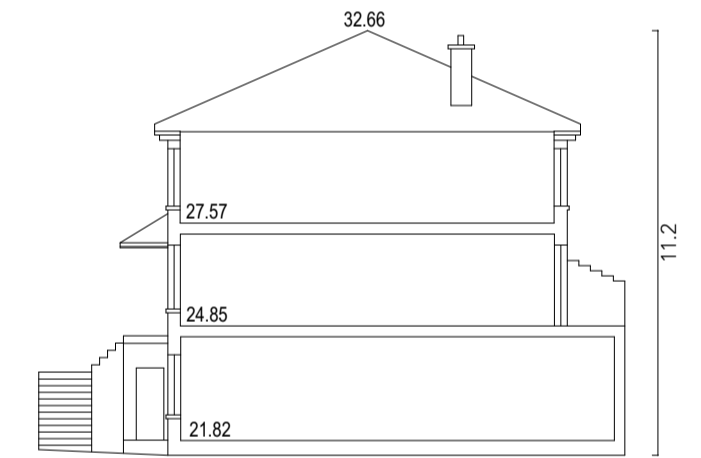

Datum 15.00 AOD Section A-A

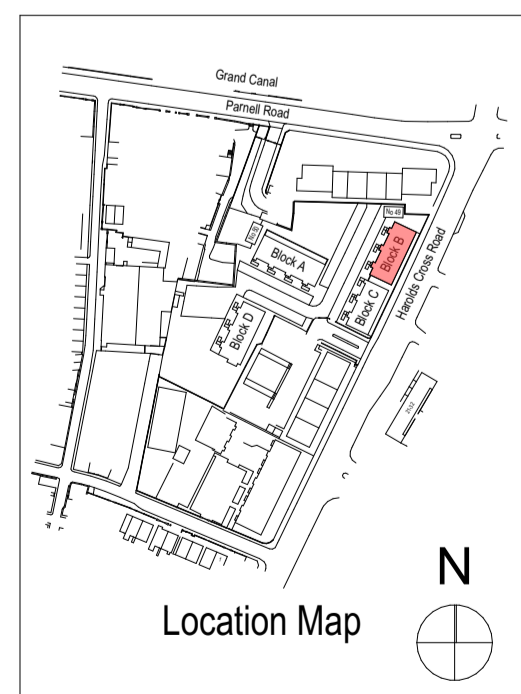

Location Map

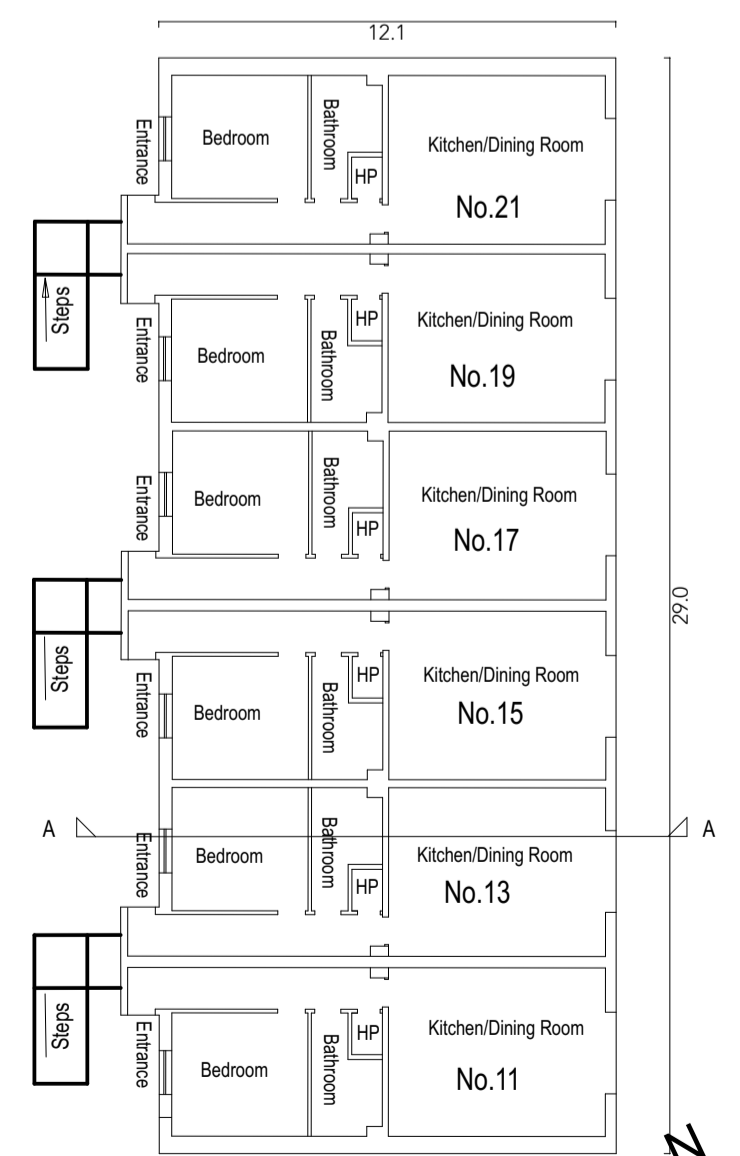

GROUND FLOOR

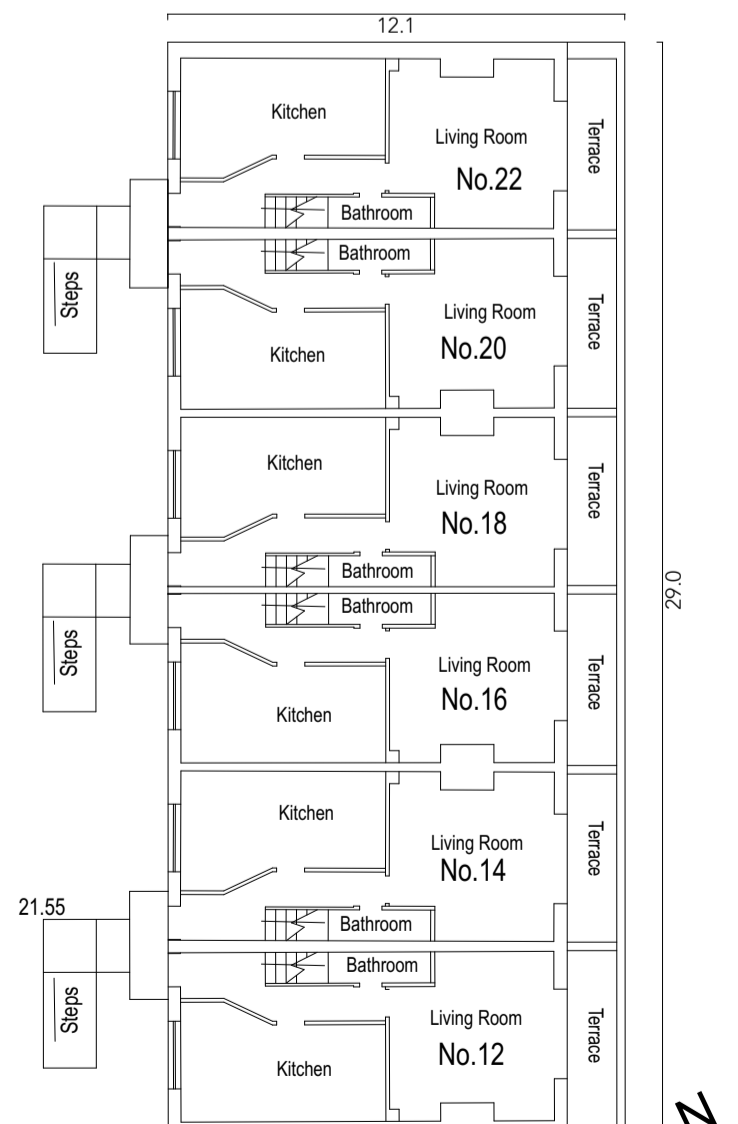

FIRST FLOOR

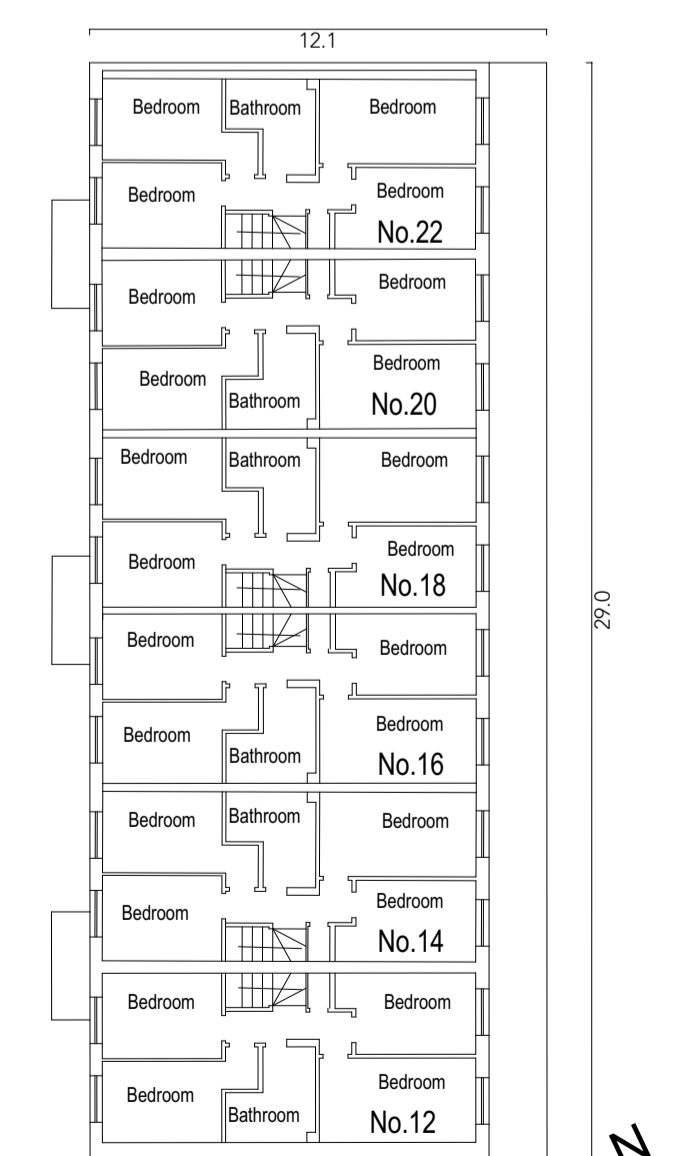

SECOND FLOOR

BLOCK B - DRAWINGS
SCALE 1:200